



**MOTOR AND CONTROL UNIT
INSTALLATION INSTRUCTIONS**

ZAP 800 and 8800 Series 3
Commercial Door
Shaft-Mounted Motor Operators

FOR INTERNAL INSTALLATION ONLY

WARNING:

To reduce the risk of injury to persons use this operator with sectional doors

ZAP by Action industries

Tel: 800.321.1130

Email: support@action-ind.com

Web: action-ind.com/zap



IMPORTANT INSTALLATION INSTRUCTIONS

WARNING: To reduce the risk of severe injury or death

1. **READ AND FOLLOW ALL INSTALLATION INSTRUCTIONS**
2. **Install only on a properly operating and balanced door. A door that is operating improperly could cause severe injury. Have qualified service personnel make repairs to cables, spring assemblies and other hardware before installing the operator.**
3. **Remove all ropes and remove, or make inoperative, all locks (unless mechanically and/or electrically interlocked to the power unit) that are connected to the door before installing the operator.**
4. **Install the Motor Operator at least 8 feet above the floor.**
5. **Do not connect the Control Unit to the source of power until instructed to do so.**
6. **Locate the Control Unit and any remote push-button stations:**
 - a. **Within sight of the door.**
 - b. **At a minimum height of 5 feet so small children cannot reach it.**
 - c. **Away from all moving parts of the door.**
7. **Install the Entrapment Warning Placard next to the Control Unit in a prominent location.**
8. **Hand the User Operating Instructions to the customer once the installation is completed.**
9. **Instruct the end user in the correct operation of the Manual Override Release Lever.**



TABLE OF CONTENT:

• Important information	1-2
• Table of content	3
• Product Overview	4
• Installation Instructions Introduction	5-6
• Fitting the Motor Operator	6-8
• Fitting the Manual Override Release Lever	8-9
• Fitting the Control Unit	10
• Fitting the motor cable	11
• Fitting the main supply cable	12
• Safety circuit wiring	13
• Photo-electric sensors	14
• Testing the door operation	14-15
• Door speed change point calibration	15-17
• Interlock circuit wiring	17
• Auto-open accessories	18
• ZAP Plug-in Radio	18
• Accessory radio receiver wiring	18-22
• Linear Megacode / Delta 3, Chamberlain 355LM	19
• Chamberlain 312HM / 365LM	19-20
• Marantec	21
• Blue Guard	22
• Programming	23
• Transmitter code programming	23
• Auto-Close timer programming	24
• Programming using the case lid buttons	24-25
• Auto-Close stay open programming	25
• Fault finding guide	26
• Programming guide	27



ZAP MOTOR-CONTROL SYSTEM FOR COMERCIAL DOORS

Patents Granted and Pending

Product Overview

825 series 3

The 825 Motor-Control System comprises:
An 800-3 Integrated Control Unit with case mounted OPEN, STOP and CLOSE buttons;
An 825 Motor Operator which is door shaft mounted and V-belt driven;
And a Bowden cable V-belt tensioning device which is released by a door frame mounted over-centre lever to facilitate manual operation of the door.

825 series 3

The 825 Motor-Control System comprises:
An 800-3 Integrated Control Unit with case mounted OPEN, STOP and CLOSE buttons;
An 825 Motor Operator which is door shaft mounted and V-belt driven;
And a Bowden cable V-belt tensioning device which is released by a door frame mounted over-centre lever to facilitate manual operation of the door.

The cable operated belt tensioning system eliminates strain on the jackshaft which is of particular benefit for applications using hollow shafts.



8825 series 3

The 8825 Motor-Control comprises:
An 8800-3 Integrated Control Unit with lid mounted OPEN, STOP and CLOSE buttons;
An 8825 Motor Operator which is door shaft mounted and V-belt driven;
And a Bowden cable V-belt tensioning device which is released by a door frame mounted over-centre lever to facilitate manual operation of the door.



8825 series 3 (HP) High Power

The HP version is for instances where extra lift power is needed.





MOTOR CONTROL UNIT INSTALLATION

Please ensure that you have the correct operator for your door before starting the installation.

Motor Operator	Maximum door size	Maximum weight	Min height	Max height	Max cable drum dia	Typical applications
825-3-B	130 sq ft	590 lbs	6 feet	19 feet	6 inches	Low headroom and standard lift doors
825-3-C	130 sq ft	590 lbs	6 feet	32 feet	8 inches	Doors with up to 54" of high lift
825-3-D	130 sq ft	590 lbs	6 feet	32 feet	10 inches	High lift and vertical lift doors
8825-3-B 8826-3-B	280 sq ft	1280 lbs	8 feet	19 feet	6 inches	Low headroom and standard lift doors
8825-3-C 8826-3-C	280 sq ft	1280 lbs	8 feet	32 feet	8 inches	Doors with up to 54" of high lift
8825-3-D 8826-3-D	280 sq ft	1280 lbs	8 feet	32 feet	12 inches	High lift and vertical lift doors

The ZAP Controls' range of Motor-Control Systems for commercial doors provides a new concept in safety control and the elimination of the inherent problems with many existing door operators.

The ZAP 800 and 8800 series 3 low voltage DC Motor-Controls operate without limit switches and may be operated without a safety edge.

The Control Unit monitors the motor load and interprets a sudden increase in load as either an obstruction or the limit of door travel.

A significant advantage of the ZAP drive system with its soft start and its fast obstruction sensing, is that when an object obstructs the door's travel, the cables will probably never jump off the cable drums.

Prior to the installation of the ZAP motor operator, test to see if the door will roll forwards under its own weight from the fully open position when the door shaft is rotated, in which case you will be able to install operator without the need for buffer-springs.

If the door will not roll forwards or there isn't a physical stop at the fully open position then a set of buffer springs or leaf springs should be fitted at the fully open track position to provide an initial push to start the door closing and to provide a physical stop, which is sensed by the Control Unit. (Pic 4)



PIC4



Ensure that the door is free to move by hand pressure. Check that it is balanced preferably with the spring tension biased slightly open. (Pic 5)

If the door movement is stiff at any point, the roller wheels should be adjusted to allow the door to be moved by hand pressure without any significant force. Any misalignment of track sections should be corrected to ensure the door runs smoothly.



PIC5

Counterbalance springs will weaken over time and the balance will become biased closed. The ZAP obstruction sensing system automatically adjusts to changes in door balance over a period of time. However springs should be checked and adjusted on a service visit, at least every six months.

A service-due reminder is provided in the Control Unit, which can be enabled to prompt the customer to call the installer after 19,200 door operations or 9,600 door cycles. (See page 25 and 27). The service due reminder is intended to provide adequate warning for the counterbalance springs to be replaced before they break.

FITTING THE MOTOR OPERATOR

The Motor Operator kit includes an anti-torque arm, which is bolted to the Super-Drive back-plate and linked to a spare or drilled hole on the jackshaft bearing plate or onto the door frame.

A torque arm is supplied with a spacer if required, if the torque arm offset is insufficient to clear any track support metalwork then the spacer provided can be used to increase the offset. (Pic 6)

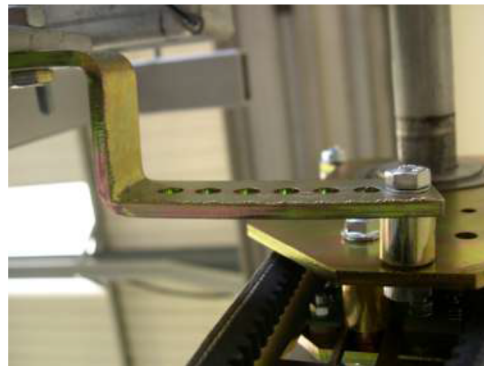

PIC6

Screw the torque arm to the bearing plate hole or door frame securing point before mounting the Super-Drive. (Pic 7)



PIC7



The Motor Operator must be mounted at least 8' above the ground to prevent entrapment in the mechanism. It is possible to mount the operator horizontally or vertically but it is critical that the torque arm is at right angles to the operator. This will ensure that operator movement is minimised by keeping the torque arm perpendicular to the operator. (Pics 8 & 9)

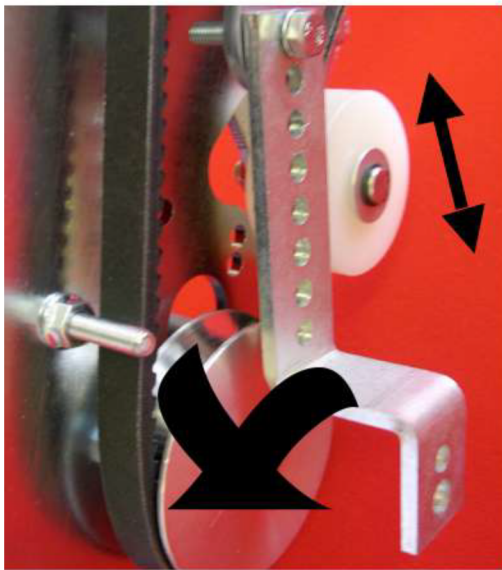

PIC8

EXCEPTION:

It is important that the 8826 chain-hoist operator is mounted vertically in a position where the chain can hang freely (Pic 10). If the 23 foot chain-hoist chain supplied on the operator is not long enough then the supplied 16 foot length of extra chain can be spliced in.

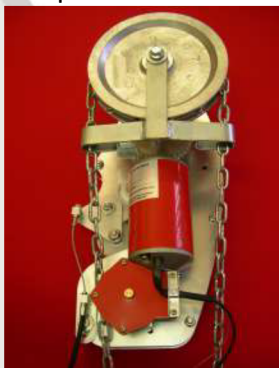

PIC10

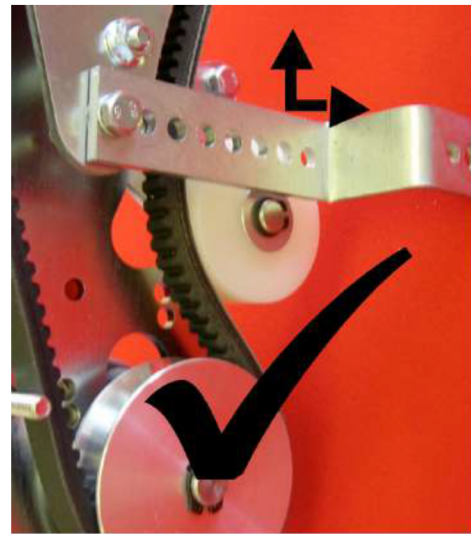

PIC9

Now slide the Motor Operator assembly onto the door shaft and bolt the torque arm to the Super-Drive back plate. (Pic 11)

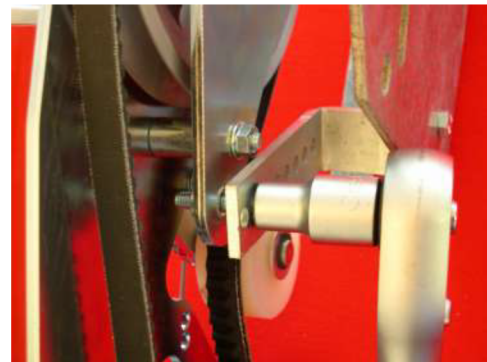

PIC11

Next tighten the torque arm bolts. (Pic 12)



PIC12



Align the operator driven pulley's keyway with the door shaft keyway and fit the key supplied with the package. Ensure that the Allen screws are firmly tight and then tighten the lock nuts. (Pic 13)



PIC13

If there is no keyway the hollow door shaft should be drilled. Mark the shaft, remove the Motor Operator and drill with a 6mm or 1/4 -inch drill bit. Replace the Allen screw in the keyway of the driven pulley with the long Allen screw supplied in the kit.

Replace the Motor Operator and re-tighten the torque arm bolts. The long screw should be screwed into the drilled hole in the shaft and tightened against the inside wall of the opposite side of the shaft. The lock nuts should then be tightened to lock the Allen screws into position. (Pic 14)

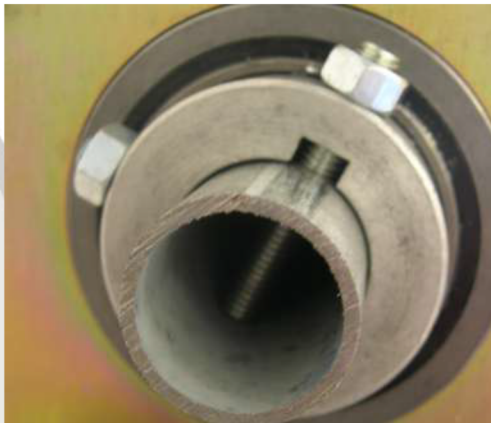

PIC14

FITTING THE MANUAL OVERRIDE RELEASE LEVER MECHANISM

The Manual Override Release Lever should be mounted 6' above the ground. The cable bracket, which secures the Bowden cable outer sheath, is fixed to the door track or frame using two M6 flat head screws and flange nuts supplied. Drill two M6 or 1/4" holes in the door track or frame in a position at least 50mm or two inches higher than the fully extended position of the outer cable to allow flexibility of movement for the Bowden cable. (Pic 15)

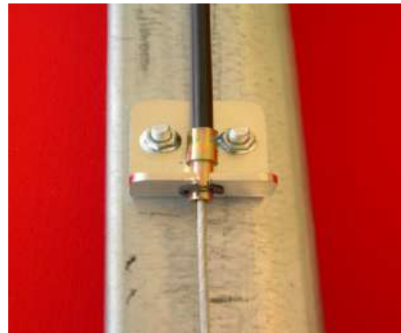

PIC15

Position the lever relative to the position of the end of the inner cable with the lever in the horizontal position.

Mark the hole positions for the Manual Override Release Lever on the door track or frame approximately 6 feet from the floor. Drill two M5 or 7/32nd of an inch size holes. (Pic 16)



PIC16



Fit the M5 screws provided with the screw head on the inside of the track or door frame. Fit the M5 flange nuts.

Secure the hook in a convenient link of the chain or cable D-shackle. (Pic 17)



PIC17

If the Bowden cable is not long enough for the height of the door then the cable can be extended using the accessory length of chain supplied. (Pic 18)



PIC18

Ensure the lever is horizontal when the tension is taken up. (Pic 19)



PIC19

It is important that sufficient tension is achieved to ensure that the drive belt does not slip on the motor pulley. The lever should require reasonable hand pressure to lock it into place. The lever hook position is adjustable to allow the Motor Operator V-belt to be correctly tensioned. Adjust the hook position to increase, or decrease tension by screwing it in or out of its bush. (Pic 20)



PIC20

When the lever tension is correct, push the lever down completely so as to correctly tension the V-belt drive. (Pic 21 - overleaf)



PIC21

FITTING THE CONTROL UNIT

Check that the Control Unit voltage select switch is set in the correct position for the available single phase supply voltage. The control unit will operate on 50 or 60 cycle single-phase supplies.

The Control Unit should be mounted 5 feet above the ground, in sight of the door and away from all moving parts of the door. The mounting screws should go through the corner pillar mounting holes, which are outside of the waterproof gasket. (Pics 22 & 23)



PIC22

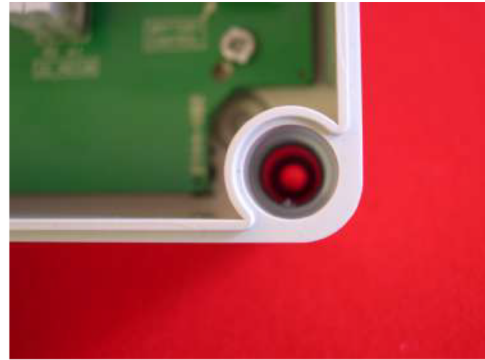

PIC23

Do not drill holes in the back of the case, as this is liable to allow water ingress and cause damage to the back of the printed circuit board.

Site the Control Unit so that any conduits are routed to the BOTTOM of the case. DO NOT drill the top or sides of the case as condensation within the conduit will run down onto the panel and cause operating problems and probable damage.

If the printed circuit board has to be removed from its case, ensure that it is handled with care and not placed on its back on any hard surfaces as this may damage the ceramic surface mount components on the rear of the printed circuit board



LOW VOLTAGE DC MOTOR WIRING

The motor supply connections should be completed next using the two core cable harness supplied.

The cable harness connector should be plugged into the model 800 motor gearbox socket. (Pic 24)

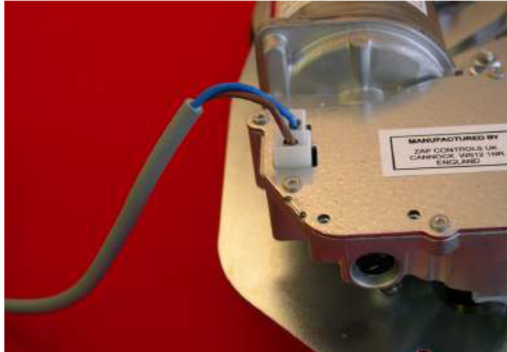

PIC24

The cable harness connector should be plugged into the free socket on the 8800 series motor. (Pic 25)

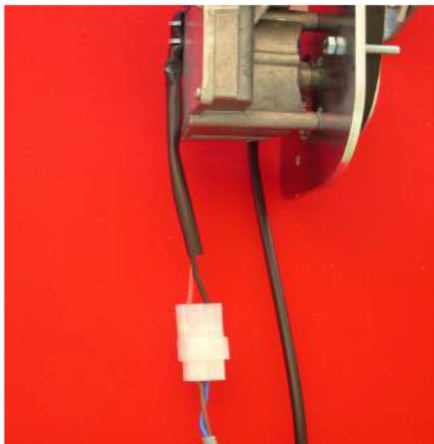

PIC25

If it is preferable not to cut off any excess cable length, it may be coiled and secured with a cable tie at the motor end.

If the motor is mounted on the LEFT hand side of the door shaft (looking from the inside outwards) then make the following connections to the DC MOTOR terminal block on the control panel:

Connect the Blue wire to the M1 terminal.

Connect the Brown wire to the M2 terminal.

If the motor is mounted on the right hand side of the door shaft (looking from the inside outwards) then reverse the connections (Blue to M2, Brown to M1).

A mistake in the wiring polarity of the motor cable will result in the door moving in the opposite direction to that initiated by pressing the OPEN or CLOSE push button and indicated by the LED motor run indicators, which are located at the top of the panel. In which case – reverse the connections of the Blue and Brown wires.

The DC MOTOR terminal block is located at the bottom right hand side of the panel. (Pic 26)

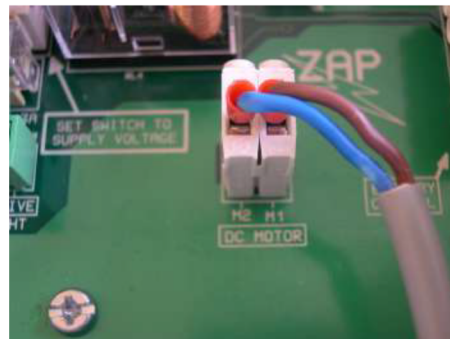

PIC26

NOTE THAT ALL TERMINALS ARE PLUG-IN FOR EASE OF WIRING and that all terminal functions are labelled on the panel.

The power supply wiring must be carried out by a qualified electrician in accordance with the local codes. The supply must be of a grounding type.

This product is intended for use with field wiring consisting of stranded copper conductors which should be routed through the bottom of the Control Unit enclosure in conduits of at least ½" diameter and carrying no more than 6



conductors per conduit so as to prevent pulling or damage to the cables. It is the responsibility of the electrician to ensure that all local electric codes are complied with during the installation of the conduits and the field wiring.

If the lighting feature is used then the main supply cable should be rated at 10 Amps continuous.

The live and neutral wires are connected to the two left-hand terminals of the green MAIN SUPPLY connector on the panel.

The earth or ground wire is connected to one of the terminals of the GROUND terminal block. (Pic 27)

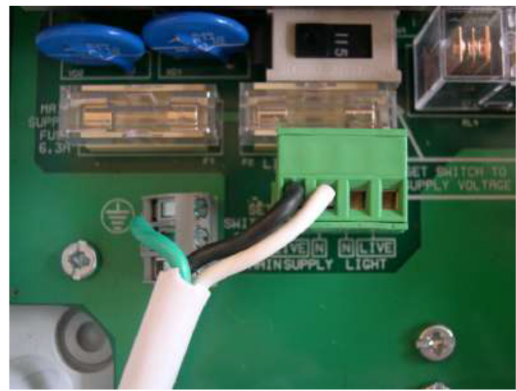

PIC27

Note that a voltage select switch is provided, which may be set at either 115V or 230V. Please be sure that the switch is set in the correct position for the local power supply voltage before the final connections are made. The Control Unit will operate on both 50 cycle and 60 cycle supply frequencies.

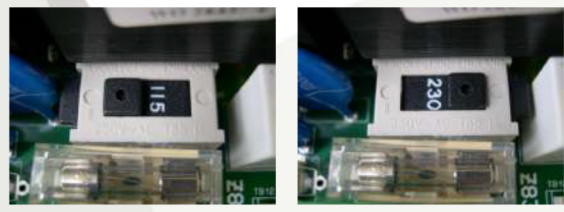

If the lighting output is to be used to operate a dock light or a flood light then the lighting wires should be routed to the two right hand terminals of the GREEN supply connector. The lighting circuit wiring should be rated at 6.3 Amps.

If the lighting output is to be used, then the DOCK LIGHT switch No. 6 should be set as required. The 6 way DIP switch is located at the top right hand side of the printed circuit board panel. (Pic 28)

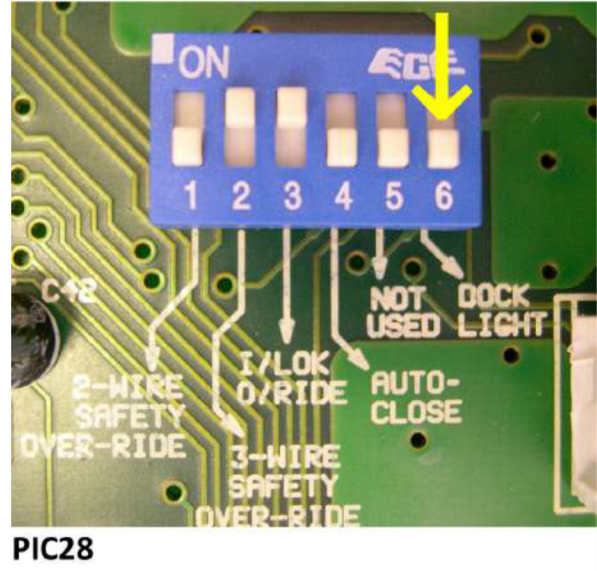

PIC28

PIC28

DIP switch No.6 should be set to the OFF position if the light is required to switch on when the door is operated and turn off three minutes after the last operation.

Switch No. 6 should be switched ON if the light is required to switch ON when the door is opened and switch OFF when the door is closed. This mode of operation is normally used for a Loading Bay Dock Light.



If a Remote Push Button Station is to be fitted then both the OPEN and CLOSE push buttons are wired in parallel with the case mounted buttons and terminated in the push button connector on the printed circuit board. (Pic 29)

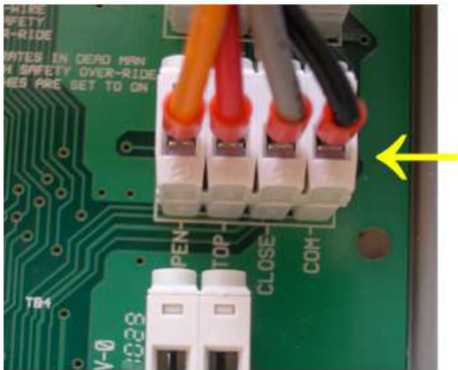

PIC29

The remote STOP push button should be wired to the interlock terminals and the interlock over-ride switch No. 3 (marked I/LOK O/RIDE) should be set to OFF.

SAFETY CIRCUIT WIRING

If the door is to be operated without any safety devices then the SAFETY OVER-RIDE switches, DIP switches No. 1 and No. 2, should be set to the ON position. In these circumstances the door will only move in the CLOSE direction by Dead-Man operation of the CLOSE button.

The door will then stop if the CLOSE button is released while the door is closing.

If a safety device such as a photo-electric sensor or safety edge is to be fitted then the related SAFETY OVER-RIDE switch - DIP switch No 1 or No. 2 - should be set to the OFF position. This provides a Safety Stop and Reopen control of the door if the safety circuit becomes active whilst the door is closing.

If a 3-wire photo-electric sensor with a resistive terminated circuit is fitted then the photo-electric sensor output wires should be connected to the 3-WIRE SAFETY terminals (TB5) at the top right hand side of the panel (Pic 30). Note that the 24 volt supply for this device is available from the outer terminals of TB5 marked +24V and COM.

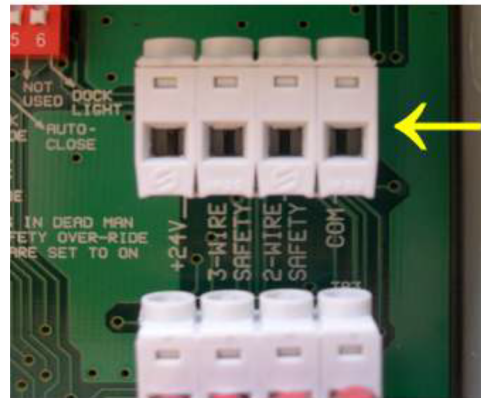

PIC30

If a 2-wire photo-electric sensor is fitted then the photo-beam output wires should be connected to the 2-WIRE SAFETY terminal and COM (TB5). (Pic 30)

Each time the safety circuit is activated LED LD2 will illuminate; this is useful when testing the operation of the photo-beam or other safety device without running the door. (Pic 31)



PIC31

If the safety circuit is interrupted whilst the door is closing it will stop and reopen.



If the safety circuit is interrupted whilst the door is operating with the Auto-Close timer DIP switch No. 4 set to ON then the timer will reset during each interruption of the safety circuit whilst the door is open.

PHOTO-ELECTRIC SENSORS

It is preferable to install a photo-electric sensor across the doorway prior to testing the door operation.

TWO WIRE SENSORS

The Control Unit will operate with Fraba, Genie and Linear two wire sensors. Please refer to the instructions supplied with the two wire sensor for the correct installation procedure.

The two wires from the sensor should be connected to the terminals marked 2-WIRE SAFETY and COM. Note that some makes of sensors are polarity sensitive, in which case wire the negative wire into the terminal marked COM.

THREE WIRE SENSORS

The Control Unit will operate with three wire sensors which incorporate an 8K2 resistor in the sensing wire.

Two of the three wires from this type of sensor are for a 24v supply. The 24v positive wire should be connected to the terminal marked +24V. The negative or ground wire should be connected to COM. The third wire is the sensor wire which should be connected to the terminal marked 3-WIRE SAFETY.

Note that if either type of sensor is not fitted then the relevant DIP switch should be set to OVER-RIDE.

If the door is to be operated without a photo-electric sensor then the door may only be closed in "Dead-Man" by pressing and holding the CLOSE case lid push button.

Note that if both the 2-WIRE and 3-WIRE SAFETY OVER-RIDE switches are set to ON, the Control Unit will revert to Dead-Man operation.

TESTING THE DOOR OPERATION

When the basic wiring is complete the door operation may be tested.

CHECK THAT THE SUPPLY VOLTAGE SELECTOR SWITCH IS SET TO THE LOCAL SUPPLY VOLTAGE.



Switch on the mains power and note that the power indicator LD3 is illuminated. (Pic 32)

PIC32

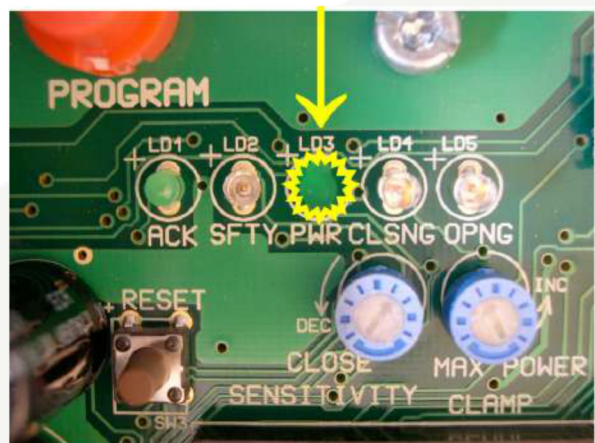



Note the factory set positions of each of the DIP switches at the top right hand side of the panel will be: (Pic 33)

- SW1 2-WIRE SAFETY OVER-RIDE: OFF
- SW2 3-WIRE SAFETY OVER-RIDE: ON
- SW3 INTERLOCK OVER-RIDE: ON
- SW4 AUTO-CLOSE: OFF
- SW5 NOT USED: OFF
- SW6 LIGHTING MODE: OFF

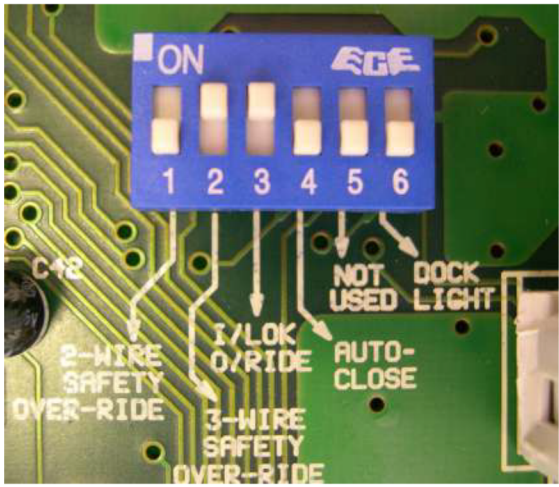

PIC33

Release the Manual Override Release Lever and move the door to a part open position, then reengage the lever.

Now press the Control Unit OPEN push button then press the STOP button after a short run.

If the door moves in the open direction then the motor wiring polarity is correct. If the door moves in the close direction, isolate the mains supply and reverse the two motor wires in the Control Unit DC MOTOR terminal block.

Release the Manual Override Release Lever and move the door back to the fully closed position, and then re-engage the lever.

DOOR SPEED CHANGE POINT CALIBRATION

After closing the door the microprocessor reference for the door start position should be reset either by pressing the black RESET button or by isolating the mains supply for at least 10 seconds. (Pic 34)

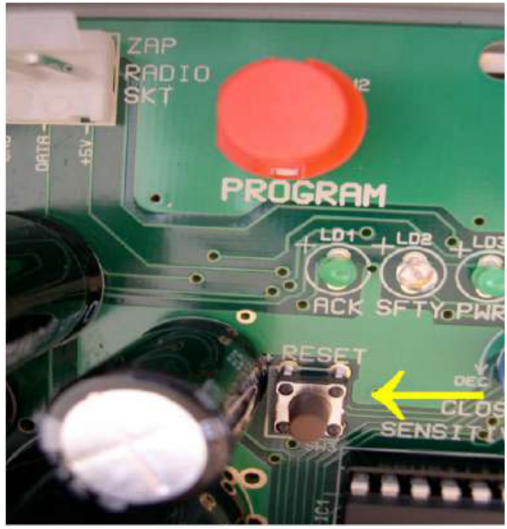

PIC34

Now press the Control Unit OPEN push button. Note that the opening (OPNG) LED, LD5 is illuminated whilst the door is opening. (Pic 35)



The door will run in fast speed for a few seconds then change to slow speed and stop when it senses a resistance to further movement at the fully open position. Make sure that the opening LED goes out as soon as the door stops moving.



The speed change points will be calibrated during the next few runs, until they are a few seconds from each end of door travel.

Now press the CLOSE button. (Press and hold the CLOSE push button if a photo-electric sensor is not fitted).

Note that the closing (CLSNG) LED, LD4, is illuminated whilst the door is closing. (Pic 36)

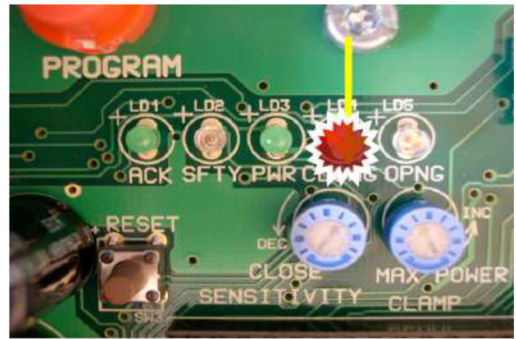

PIC36

When the door stops, make sure that the closing LED goes out immediately and release the CLOSE button, if held, and press and release the OPEN push button again.

Note that after the second open and close door cycle the microprocessor continually updates and stores the door position in the controller's memory and the speed change point will be maintained within a few seconds from each limit of door travel.

If the opening and closing LED's do not go out as soon as the door stops moving then refer to the trouble shooting guide on page 26.

If the door roller wheels are too tight or if there is some damage to the door track then the door may stop before it reaches the limit position. If track damage or stiffness is minimal then the motor power may be increased to overcome the restriction by adjusting the MAXIMUM

POWER CLAMP preset control slightly counter-clockwise. (Pic 37)



PIC37

The adjustment direction relates to the analogy of the operation of a water tap. A tap is generally turned counter-clockwise to increase the water flow. Likewise if the control is turned counter-clockwise it will allow an increase in current to flow to the motor and consequently provide extra power to move the door.

The sensitivity of the door detecting an obstruction in fast speed in the CLOSE direction may be adjusted with the CLOSE SENSITIVITY preset.

If it is required to increase the obstruction sensitivity, thus reducing the door edge pressure required to activate the Control Unit obstruction sensing circuit, which causes the door to stop and re-open during the close fast speed cycle, then the CLOSE SENSITIVITY adjuster should be turned further clockwise. (Pic 38)

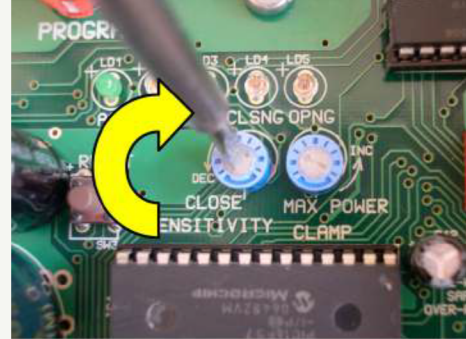

PIC38



Please note that this will also increase the possibility of the controller reacting to slight abnormalities or minor damage to the track or misalignment of track sections. This may cause fluctuations in the motor current and may be significant enough to result in the door stopping and re-opening. It is therefore important that the smooth movement of the door is tested by releasing the Manual Override Release Lever and moving the door by hand in both directions.

The impact pressure on the edge of the door may be limited further by programming the controller to close the door in slow speed. (See PROGRAMMING on page 27).

Both preset controls are factory set to the 12 o'clock position. Providing the door runs smoothly by hand in both directions it is unlikely that you will need to adjust these presets.

Note that during a build up of snow and ice for example, the door speed change point will automatically recalibrate to account for the new ground position.

If the door strikes an abnormal obstruction twice in the same position then the speed change point will recalibrate to account for the change. For example where a pallet has been left in a position obstructing the closing door.

(Pic 39)



PIC39

This feature also handles recalibration of the door position if it has been moved by hand during a power supply failure. The speed change points will automatically recalibrate with reference to the new limit of door travel positions following manual repositioning of the door.

A significant advantage of the ZAP drive system with its fast obstruction sensing, is that when an object obstructs the door's travel, the cables will probably never jump off the cable drums.

INTERLOCK CIRCUIT WIRING

A pair of terminals is provided to enable a pass door switch or a key switch to be interlocked to the Control Unit, to prevent the main door opening if the interlock terminals are open circuit. (Pic 40)

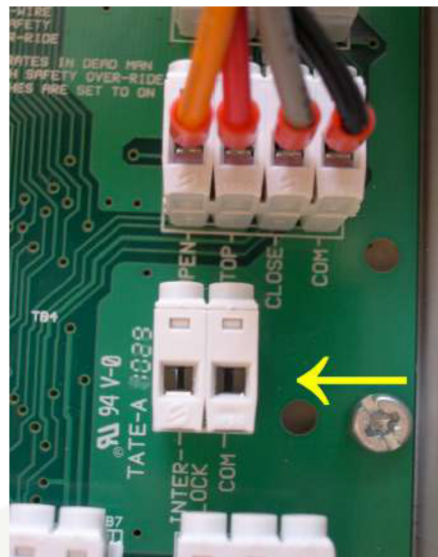

PIC40

An interlock override switch, DIP switch No. 3 marked I/LOK O/RIDE, is provided if the interlock circuit is not used.

A slide lock switch may be fitted and wired to the interlock terminals. However this is not essential as the Control Unit will detect the obstruction and stop the door if the slide lock is left in the locked position.



AUTO-OPEN ACCESSORIES

Where it is required to automatically open the door by the operation of an accessory device such as a magnetic loop vehicle detector, a Radar unit, a photo-electric sensor or other remote switch then the Normally Open switching circuit of the device should be connected in parallel with the OPEN push button wiring at the panel terminal block.

One wire should be connected to the OPEN terminal together with the OPEN push button wire from the case lid button. The other wire should be connected to the COM terminal with the existing common wire.

ZAP PLUG-IN RADIO

A ZAP Model 840 Plug-in Radio Receiver is available (Pic 41), which can be plugged into the three-way connector located at the top left hand side of the panel.

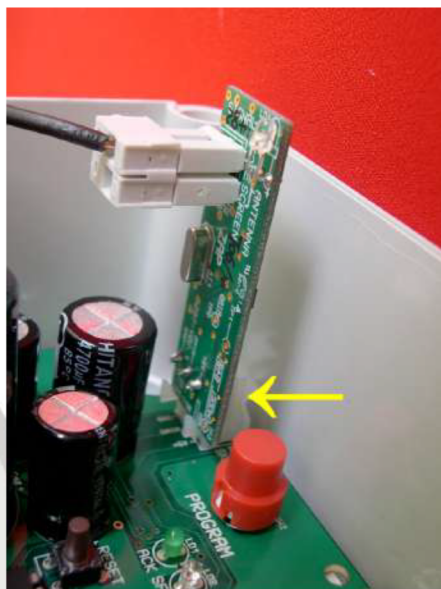

PIC41

An internal antenna model 4116 may be plugged into the radio antenna socket to

provide a reasonable operating range. The cable of a model 4114 wall-mounting antenna kit may be connected if a greater operating range is required.

The Control Unit has a memory for up to 60 ZAP transmitter codes. Transmitter code programming is covered in the programming section.

Operation of a ZAP transmitter button is PRESS-TO-OPEN, PRESS-TO-STOP, PRESS-TO-CLOSE, and PRESS-TO-STOP.

However if a safety sensor is not fitted then the remote control CLOSE function will not be operable.

If the AUTO-CLOSE DIP switch No. 4 is set to ON and a safety sensor is fitted then the transmitter may only be used to open the door. The door will Auto-Close after a preset delay.

ACCESSORY RADIO RECEIVER WIRING

A 24-volt accessory may be powered from the 24-volt DC accessory supply terminals of the 3-way terminal block at the lower right hand side of the panel.

The 24-32V dc 1A supply may be used to power other accessories such as a magnetic loop detector, Radar units or an accessory radio receiver (non ZAP).

Note that if a safety sensor is not fitted then the remote control CLOSE function will not be operable.

Isolate the power supply before wiring any device into a ZAP Controller.



Wiring a Linear Mega-code / Delta 3 receiver or a Chamberlain 355LM:

It is feasible to mount the receiver inside the case lid of the ZAP Controller. Ensure that it is positioned as shown in (Pic 42). You may secure the receiver in place using double sided tape.



PIC42

All wiring for the radio receiver onto the ZAP control board is connected to the radio wiring connector as indicated in (Pic 43) and highlighted in yellow.

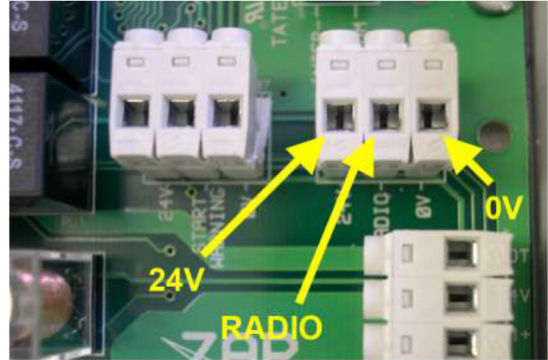

PIC43

Terminal 1 (Common) on the receiver (Pic 44) is wired and terminated into the 0V connection on TB9. (Pic 43)

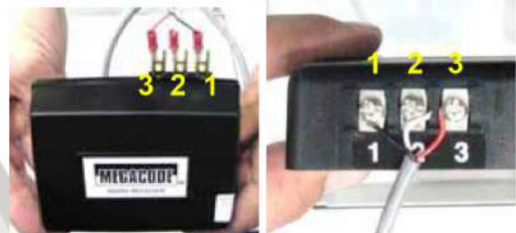

Linear

PIC44

Chamberlain

If cyclic operation by radio control is desired, terminal 2 (Relay) on the receiver (Pic 44) is wired and terminated into the Radio connection on TB9. (Pic 43)

If only an open function is required (if the auto-close timer is employed then it is

recommended that only the open be used), wire terminal 2 of the receiver (Pic 44) to the open connection on TB3. (Pic 45)

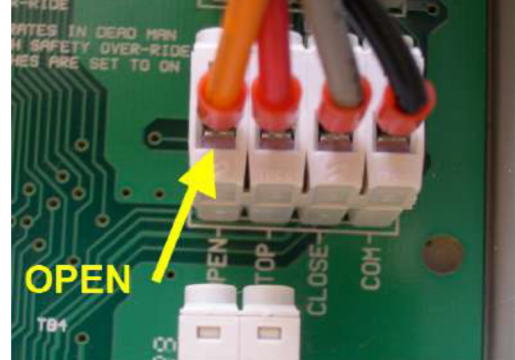

PIC45

Wire terminal 3 (Radio Power) of the receiver (Pic 44) to the 24V Power supply, labeled 24V on TB9. (Pic 43)

For the Chamberlain 355LM only: Inside the receiver, move the output duration jumper to P2 and C. (Pic 46)



PIC46

Restore the power supply and program your receiver per the radio control manufacturer's instructions.

Wiring a Chamberlain 312HM receiver:

The Chamberlain 312HM receiver doesn't fit inside the ZAP Controller. It will need to be mounted outside the ZAP controller case.

All wiring for the radio receiver onto the ZAP control board is connected to the radio wiring connector as indicated in (Pic 43) and highlighted in yellow.



Place a jumper wire between terminals 1 and 3 of the 312HM receiver. (Pic 47)

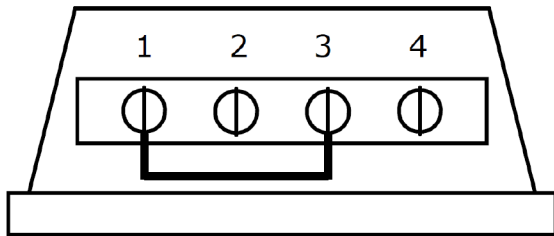

PIC47

Terminal 1 (Common) on the Chamberlain receiver (Pic 47) is wired and terminated into the 0V connection on TB9. (Pic 48)

If cyclic operation by radio control is desired, terminal 4 (Relay) on the Chamberlain receiver (Pic 47) is wired and terminated into the Radio connection on TB9. (Pic 48)

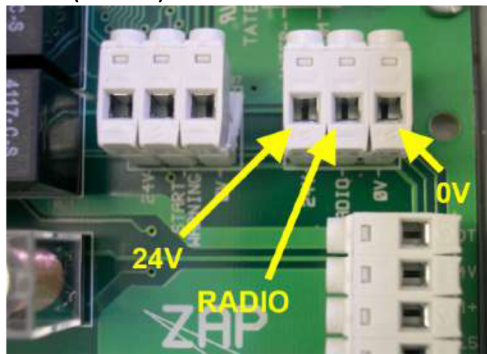

PIC48

If only an open function is required, wire terminal 4 of the receiver (Pic 47) to the open connection on TB3. (Pic 49)

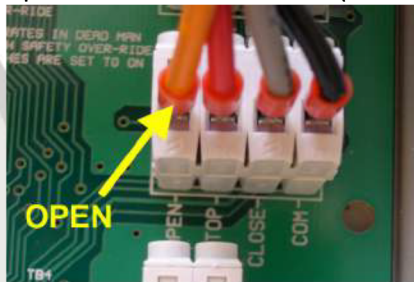

PIC49

Wire terminal 2 (Radio Power) of the Chamberlain receiver (Pic 47) to the 24V Power supply, labeled 24V on TB9. (Pic 48)

Inside the receiver, move the output duration jumper from P2 and M to P2 and C. (Pic 50)

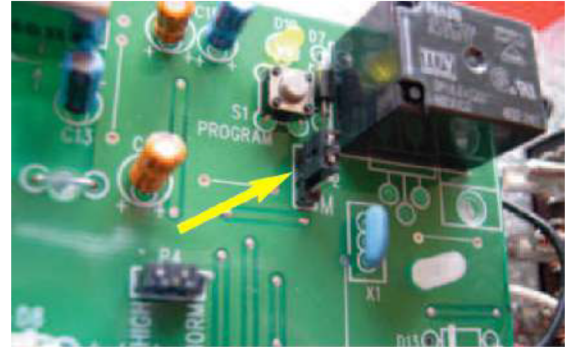

PIC50

Restore the power supply and program your receiver per the radio control manufacturer's instructions.

Wiring a Chamberlain 365LM receiver:

Terminal 1 (Right) on the Chamberlain receiver (Pic 51) is wired and terminated into the 0V connection on TB9. (Pic 48)

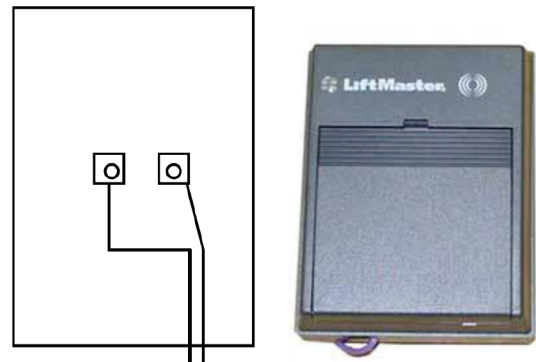

PIC51

If cyclic operation by radio control is desired, the relay terminal (Left) on the receiver (Pic 51) is wired and terminated into the Radio connection on TB9. (Pic 48)

If only an open function is required, wire the relay terminal (Left) on the Chamberlain receiver (Pic 51) to the open connection on TB3. (Pic 49)

Plug the receiver into a 115V power supply and program your receiver per the radio control manufacturer's instructions.



Wiring a Marantec receiver:

Terminal 1 (Right) on the Marantec receiver (Pic 52) is wired and terminated into the 0V connection on TB9. (Pic 53)

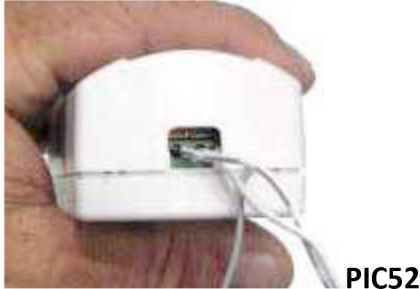

PIC52

If cyclic operation by radio control is desired, the relay terminal (Left) on the Marantec receiver (Pic 52) is wired and terminated into the Radio connection on TB9. (Pic 53)

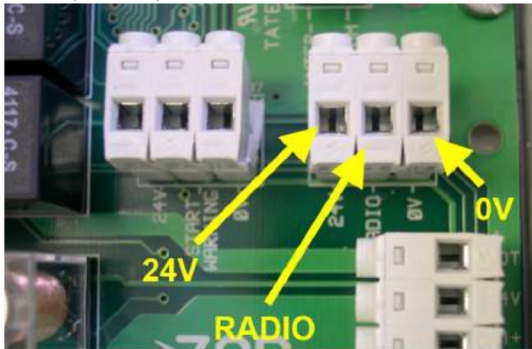

PIC53

If only an open function is required (If the auto-close timer is employed then it is recommended that only the open be used), wire the relay terminal (Left) on the Marantec receiver (Pic 52) to the open connection on TB3. (Pic 54)

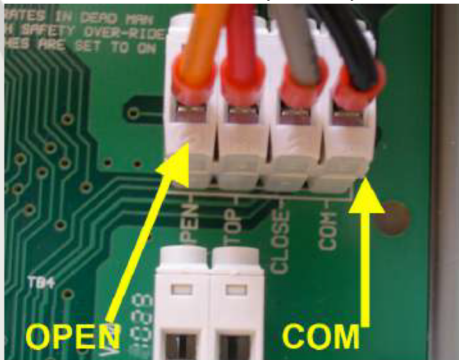

PIC54

Plug the receiver into the 115V power supply, restore the power supply and program your receiver per the radio control manufacturer's instructions. (Pic 55)



PIC55

Other available functions:

It is possible to interface the ZAP Control unit to a variety of third party products in order to provide dock control, air-lock, home automation and other functions.

The available inputs are open, close, cycle, stop, safety and interlock.

With the addition of an interface module, the following outputs can be obtained:

Door moving, door fully open, door fully closed, door not fully open, door not fully closed and "door about to start closing" (when a close delay is programmed).

Please contact your distributor for further information and advice.



Wiring a Blue Guard VK virtual keypad or a Blue Guard FE free entry device:

The Blue Guard Virtual Keypad and Blue Guard Free Entry devices allow the end user to link door operation to Bluetooth enabled cell phones allowing the phone to act as an access card or a keypad.

Read and follow all instructions provided with the device. Isolate the power supply before wiring any device into a ZAP Controller.

Introduce the wiring cable into the controller case through the provided predrilled holes in the bottom of the controller and mount the Blue Guard device to the bottom of the ZAP controller or on an interior or exterior wall.

Wire the power wire to the 24V connection on TB9 (Pic 56)

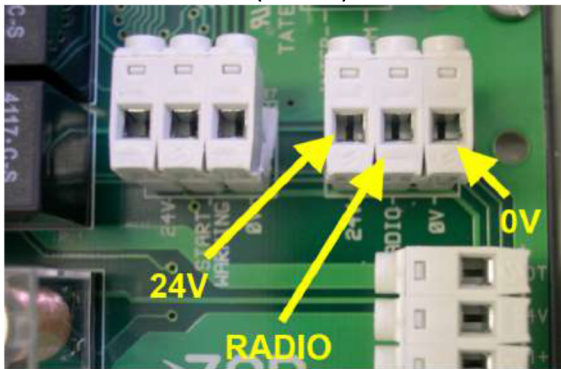

PIC53

Wire the power common wire to the 0V connection on TB 9. (Pic 56)

To function as a Virtual Keypad or Free Entry device causing cyclic operation, wire the N/O wire to the Radio connection on TB9, and the N/O common to the 0V on TB9. (Pic 56)

To function as a Virtual Keypad or Free Entry device causing only an open function wire the N/O wire to the OPEN

connection on TB3, and the N/O common to the COM on TB3. (Pic 57)

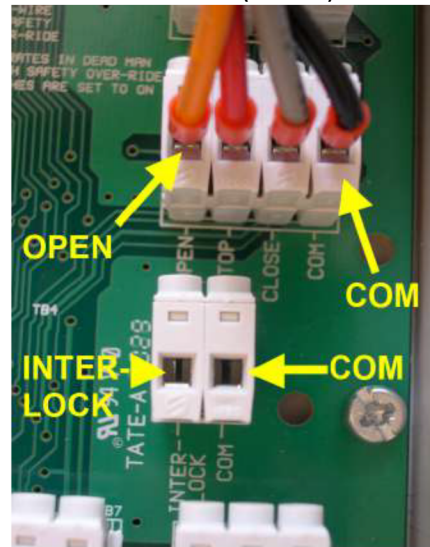

PIC57

To function as a virtual card reader (the presence of the phone unlocks the open and close buttons) using the Blue Guard FE, wire the N/C wire to the INTERLOCK connection on TB4 (Pic 56) and the N/C common to the COM on TB4. (Pic 57) and turn DIP Switch 3 OFF. (Pic 58)

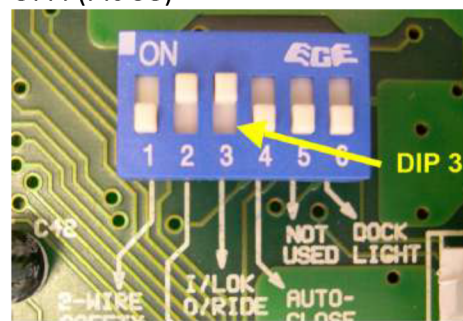

PIC58

Restore the power supply. Program and test the device per the manufacturer's instruction. (Pic 59)



PIC59



PROGRAMMING

The following functions can be enabled using the PROGRAM button, which is located at the top of the panel. (Pic 60)

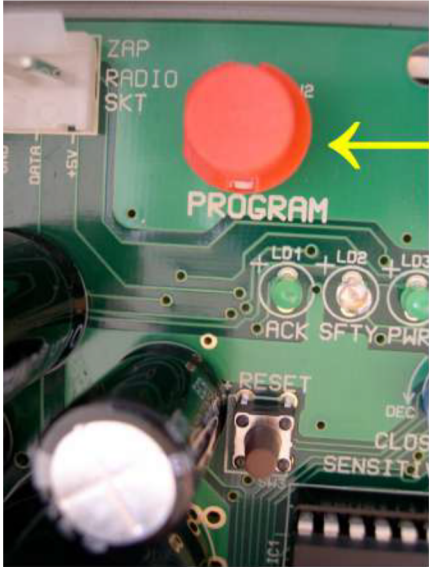

PIC60

When the PROGRAM button is pressed and held a sequence of flashes of the acknowledge (ACK) LED follows at 4-second intervals. If an optional Plug-in Beeper Module (PIC 61) is fitted then the beeper sounds in conjunction with the flashes of the LED.



PIC61

The first flash or beep indicates the remote control transmitter program mode.

The second flash or beep indicates the Auto-Close timer program mode.

The third flash or beep indicates the close delay program mode, which allows the optional Warning Speaker to sound before the door starts to close.

The fourth flash or beep indicates the transmitter code memory erasure mode.

The PROGRAM button should be released after the appropriate flash or beep to enter the required program mode.

All of the programmed functions are stored in a non-volatile memory, which is retained during a power interruption.

A quick reference programming chart can be found on page 27 at the back of this booklet.

ZAP TRANSMITTER CODE PROGRAMMING

(Note: a ZAP Model 840 Radio Receiver should be fitted)

To program a ZAP transmitter code into memory:

First press and hold the required transmitter button. Then press and hold the PROGRAM button.

Release the PROGRAM button after the first LED flash or beep.

Two flashes or beeps confirm that the code has been stored into memory.

Now release the transmitter button.

Three flashes or beeps indicate that no code data was present in which case, repeat the programming sequence.

Up to 60 transmitter codes can be stored in memory. In which case repeat the programming sequence for each of the new transmitters (each transmitter has a different operating code).



To erase all transmitter codes: Press and hold the PROGRAM button and release it after the FOURTH flash or beep.

Two flashes or beeps acknowledge that all of the transmitter codes have been erased.

AUTO-CLOSE TIMER PROGRAMMING

NOTE THAT THE DOOR WILL NOT AUTO-CLOSE UNLESS A PHOTO-ELECTRIC SENSOR IS INSTALLED AND CONNECTED TO TB5 AND THE RELEVANT SAFETYOVER-RIDE DIP SWITCH IS SET TO OFF.

The factory set Auto-Close timer delay is 15 seconds.

In order to confirm the operation of the Auto-Close timer, first set DIP switch No. 4 to ON. Then press the OPEN push button. The door will open and re-close after the time delay.

To change the time delay first ensure that DIP switch No. 4 is set to the ON position and that the door is fully closed.

Now press and hold the PROGRAM button. Release the button after the SECOND flash or beep.

Next press the OPEN push button.

After the door has fully opened and after the required delay press the CLOSE push button. This new delay is now stored into the memory and will be retained during any power interruptions.

A sequence of 6 flashes and beeps follow to prompt you to decide if you want the door to Auto-Close regardless of the door reopening after striking an obstruction.

It is preferable that the door should reopen and stay open following an obstruction strike. However it may be required for security reasons, when used

as a car wash door for example, that the door should Auto-Close after reopening after hitting a large build-up of snow and ice in winter, in which case it will make two attempts to close onto the ice. On the third run it will then stop on the ice.

If you require the door to Auto-Close regardless of obstructions then press and release the CLOSE button a second time during the 6 flashes and beeps.

If the CLOSE button is not pressed during the flashes and beeps the controller will default to stay open after an obstruction reopen sequence.

If it is required to change the programmed delay then repeat the programming sequence.

PROGRAMMING USING THE CASE LID BUTTONS

A door operations counter is incorporated. The number of door operations can be counted more easily by fitting a Plug-in Beeper Module, which sounds in conjunction with flashes of the acknowledge LED indicator.

The door operations counter may be used at any time by pressing and holding both the STOP push button and the OPEN push button and releasing them after a beep is heard or after the first flash of the acknowledge (ACK) LED.

The beeper will then indicate the total door operations since the door was installed by sounding long beeps for 1000's of operations and short beeps for 100's of operations. The acknowledge (ACK) LED provides simultaneous long and short flashes.

Two long beeps and three short beeps or two long flashes and three short flashes of



the LED for example indicate that the door has completed 2300 operations. If there is no response after releasing the buttons the door has completed less than 100 operations.

A service due reminder is incorporated in the Control Unit. This prompts the customer to call the installer when the door requires servicing. A Model 850 Plug-in Beeper Module should be installed.

The service due reminder operates after 19,200 door operations or 9,600 door cycles, which allows for a warning to be given before it is time to replace standard 10,000 cycle torsion springs. After the door has completed 19,200 operations the service due reminder becomes active and delays the door close cycle by ten seconds during which time the beeper will sound ten times.

The service due reminder is NOT enabled during manufacture. It may easily be enabled during the installation through the following programming procedure:

Press and hold the STOP push button. Then press and hold the OPEN button. Release the buttons after the SECOND beep.

Two beeps confirm that the service due reminder is enabled.

The service due reminder can be reset during the service visit by repeating the enable sequence.

If it is required to disable the service due reminder then press and hold both the STOP and OPEN buttons. Release them after the third flash and bleep. Two flashes or bleeps confirm the service due reminder is disabled.

AUTO-CLOSE - STAY OPEN PROGRAMMING

If the Auto-Close function is active then it may be necessary to temporarily disable the Auto-Close function; for example when it is required to hold the door open on a warm summer's day.

The Auto-Close can be temporarily disabled by opening the door and waiting for the door to stop in the open position. Then press and hold the STOP button. Then press and hold the CLOSE button. Release the buttons after the beep (the analogy being - *STOP CLOSING*).

The Auto-Close function will operate normally after the door is next closed using the CLOSE push button.



FAULT FINDING GUIDE

FAULT 1. The green power (PWR) light is not on.

REASON & REMEDY

The voltage selector switch is not set correctly. Turn off the mains supply, set the voltage selector switch to the correct value and turn the mains supply back on.

FAULT 2. The opening (OPNG) or closing (CLSNG) LED remains illuminated after the door has stopped moving.

REASON & REMEDY

The V-belt tension is too loose and the belt is slipping over the motor pulley. Increase the tension by releasing the Manual Override Release Lever and screw the hook in a few turns. Also reduce the MAX POWER CLAMP by turning the adjuster 20° clockwise.

FAULT 3. The door stops just after it has started moving in the open direction.

REASON & REMEDY

- A. The door movement is stiff due to the door running tight against the door frame in the fully closed position. In which case adjust the position of the roller wheel supports to ease the pressure of the door against the frame.
- B. The door is badly out of balance. In which case re-tension the counterbalance springs.
- C. The door is near the maximum weight for the operator and the MAX POWER CLAMP adjuster is set too low, in which case turn the adjuster a further 20° counter-clockwise.

FAULT 4. The closing door stops and reopens before it contacts the ground.

REASON & REMEDY

- A. There is an abnormality in the track, which is causing the roller wheels to jump. This may be due to a misalignment of track sections or a deformed or damaged section of track. In which case correct the track problem and ensure the door will run smoothly by hand movement with the Manual Override Release Lever disengaged.
- B. The CLOSE SENSITIVITY adjuster is set too fine. In which case turn the adjuster counter-clockwise by a further 20°.

FAULT 5. The door runs in slow speed for an extended period of time.

REASON & REMEDY

- A. The V-belt is slipping. In which case adjust the belt tension and reduce the maximum power as described in 1. above. Then run the door fully open and closed a few times to enable the microprocessor to recalibrate the door speed change points.



Programming Guide – Using the PROGRAM Button

Press and hold the PROGRAM button and release after the relevant beep of the beeper or flash of the acknowledge (ACK) LED.

First Beep:	Program new transmitter	See page 23
Second Beep:	Program an Auto-Close delay time	See page 24
Third Beep:	Program a close delay for warning device - Contact us	
Fourth Beep:	Erase all transmitter codes from memory	See page 24
Fifth Beep:	Ignore	
Sixth Beep:	Ignore	
Seventh Beep:	Repeated: change close speed to fast or slow – Contact us	

Programming using the case lid buttons

[See pages 24-25](#)

It is preferable that a Plug-in Beeper Module is fitted to enable the following program functions to be carried out without removing the controller lid. Note that the beeper sounds in conjunction with flashes of the acknowledge LED.

OPERATIONS COUNTER:	Press and hold the STOP button. Press and hold the OPEN button. Release after the first flash/beep. Long beeps = 1000's of operations. Short beeps – 100's of operations.
SERVICE DUE REMINDER: (Enable and/or reset)	Press and hold the STOP button. Press and hold the OPEN button. Release after the second flash/beep. Two beeps confirm the reminder is enabled/reset.
DISABLE SERVICE DUE REMINDER:	Press and hold the STOP button. Press and hold the OPEN button. Release after the third flash/beep. Two beeps confirm the reminder is disabled.
AUTO-CLOSE TEMPORARY INHIBIT: (Stay open until next closed)	Just after door has opened... Press and hold the STOP button. Press and hold the CLOSE button. (<i>STOP CLOSING</i>) Release after the flash/beep. The door will resume Auto-Closing following the next door cycle.