

### WARNING

Read and understand all instructions before beginning installation. Disconnect power to motor and test upon completion. Only qualified personnel should install to ensure the following requirements are met. Always keep these instructions with the installation and abide by local and national electrical code specifications when wiring accessories to motor controls.

The Aries™ visual alert system is an illuminated leading edge channel designed for installation on 1-3/4 in. to 2 in. thick commercial motorized sectional doors. The system integrates dual-sided, always-on bi-color LED lighting within a rigid PVC mounting channel to indicate door-status from the interior and exterior of a door. Aries connects to the commercial door operator (CDO) through the included LED controller to visually indicate door movement during operation.

Aries must be installed with an ME123 sensing edge, CPT215 sensing edge, or LS-0107 loop seal (all sold separately) to complete the door's bottom edge.

### Overview

<b>Contents</b> .....	2		
I. <b>Mounting Channel &amp; LED Strip Installation</b> .....	3	VII. <b>Troubleshooting</b> .....	9
II. <b>Junction Box Installation &amp; Door-Mounted Wiring</b> .....	5	VIII. <b>Tech Support</b> .....	9
III. <b>Controller Box Installation &amp; Wiring</b> .....	6	IX. <b>General Specifications</b> .....	10
IV. <b>Power Source Connection</b> .....	7	X. <b>Maintenance</b> .....	10
V. <b>Connecting the Door LED Controller to the CDO</b> .....	7	XI. <b>Warranty</b> .....	10
VI. <b>System Activation &amp; Testing</b> .....	9	XII. <b>Accessories</b> .....	10

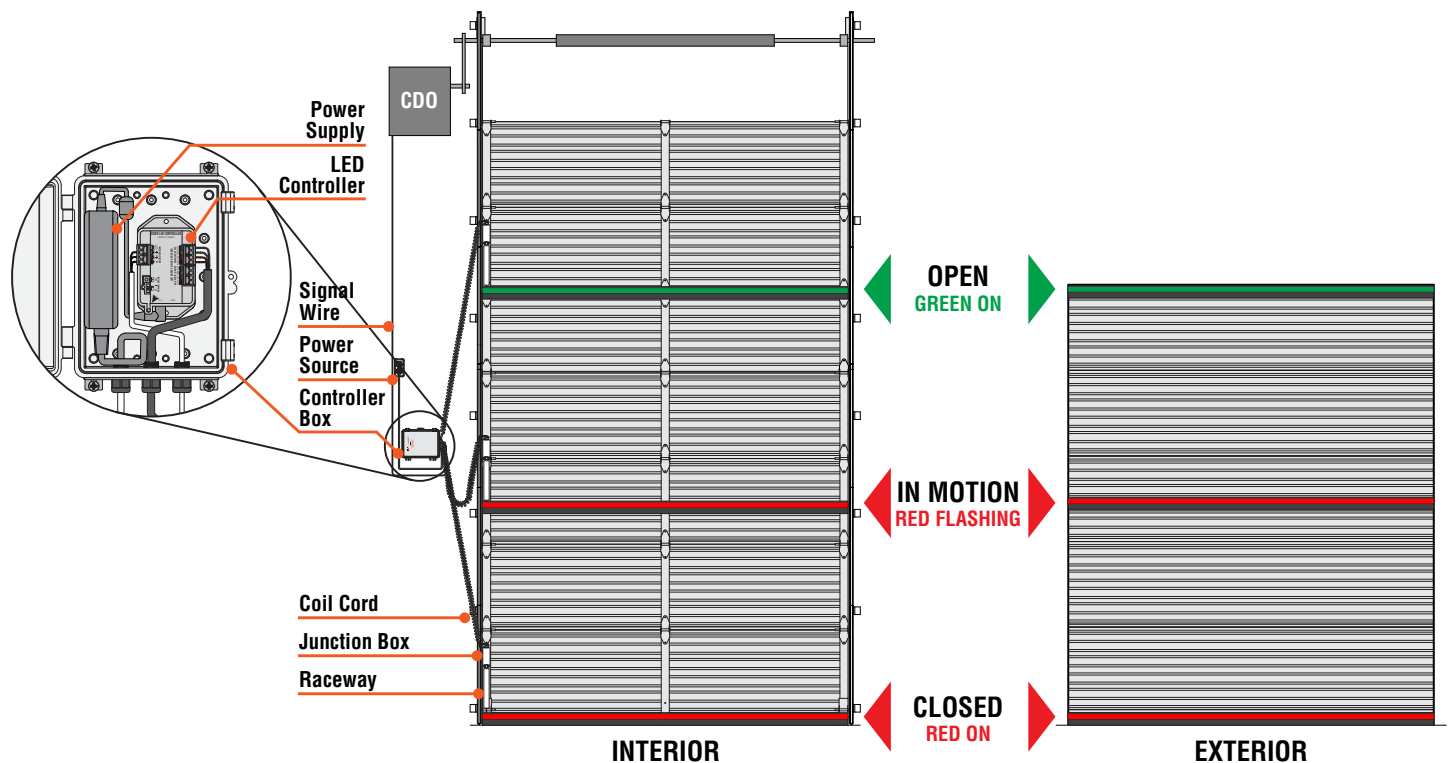

**IMAGE 1: Aries Installed on a Motorized Commercial Sectional Door**

### Contents • Length & Quantity Varies by Model

- **Model: LED-ARIES-ME123C-K8**
  - (1) 7-ft. 6-in. LED Strip
  - (1) 37-in. Mounting Channel with Wire Access Holes
  - (3) 37-in. Mounting Channels
- **Model: LED-ARIES-ME123C-K10**
  - (1) 10-ft. 2-in. LED Strip
  - (1) 37-in. Mounting Channel with Wire Access Holes
  - (3) 37-in. Mounting Channels
- **Model: LED-ARIES-ME123C-K12**
  - (1) 11-ft. 9-in. LED Strip
  - (1) 37-in. Mounting Channel with Wire Access Holes
  - (4) 37-in. Mounting Channels
- **Model: LED-ARIES-ME123C-K14**
  - (1) 14-ft. 1-in. LED Strip
  - (1) 37-in. Mounting Channel with Wire Access Holes
  - (6) 37-in. Mounting Channels

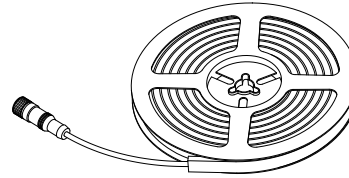

**(1) LED Strip**  
Length varies by model

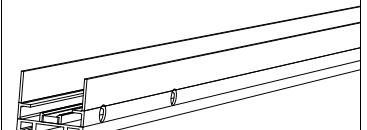

**(1) 37-in. Mounting Channel with Wire Access Holes**

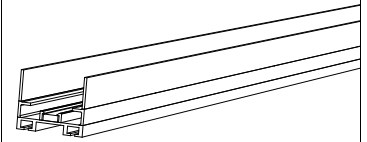

**37-in. Mounting Channel**  
Quantity varies by model

### Contents • Included with All Models

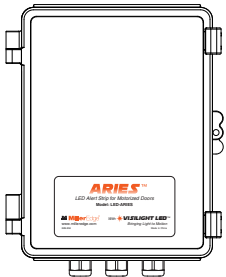

**(1) Controller Box**  
(includes power supply and door LED controller; factory assembled)



**(1) CDO Signal Cable**  
6-wire, 22 AWG, 20-ft.

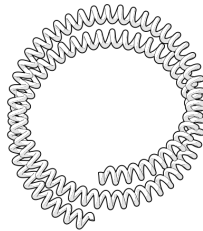

**(1) Coil Cord**  
6-wire, 22 AWG, 12-ft.

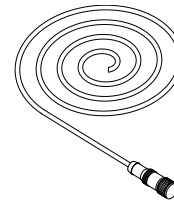

**(1) 4-ft. LED Strip Extension Cable with Threaded Connector**



**(1) Cable Raceway with VHB Tape Backing**



**(1) Junction Box**

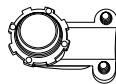

**(1) 90° Junction Box Cord Grip**



**(1) Straight Junction Box Cord Grip**



**(6) Wire Nuts**

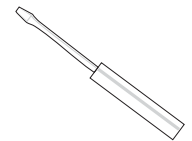

**(1) 3 mm Phillips/Flathead Screwdriver**

### Required

- **One of the following:**
    - ME123 sensing edge
    - CPT215 sensing edge
    - LS-0107 loop seal
  - CDO manual
  - Drill/driver
  - Knife, shears, or hacksaw to cut mounting channel and raceway
  - Fasteners for attaching:
    - Controller box to wall
    - Junction box to door
    - Mounting channel to door
- Tip:** When ordering a sensing edge, request a universal wire/tube outlet for installation flexibility with hardwired or wireless systems.

### Suggested

- Needle nose pliers
- Marker or pencil
- Measuring tape

### Optional

- Cable ties for wire dressing
- Wireless sensing edge transmitter/receiver system
- Cleaner and towel to prep for optional cable raceway

## I. Mounting Channel & LED Strip Installation

### 1. Setup:

- a. Identify these parts:
  - (1) LED light strip
  - (1) 37-in. mounting channel with wire access holes
  - 37-in. mounting channel sections (quantity varies by model)
  - Sensing edge or weather seal (not included):
    - ME123 sensing edge
    - CPT215 sensing edge
    - LS-0107 loop seal
- b. Raise the door to a comfortable working height (approximately **4–5 ft.** from floor). **IMAGE 2**
- c. Turn **OFF** power to the CDO and verify power is disconnected.
- d. Place a stable work surface (e.g., sawhorses with plywood) beneath the partially open door to support the sensing edge or weather seal during assembly.

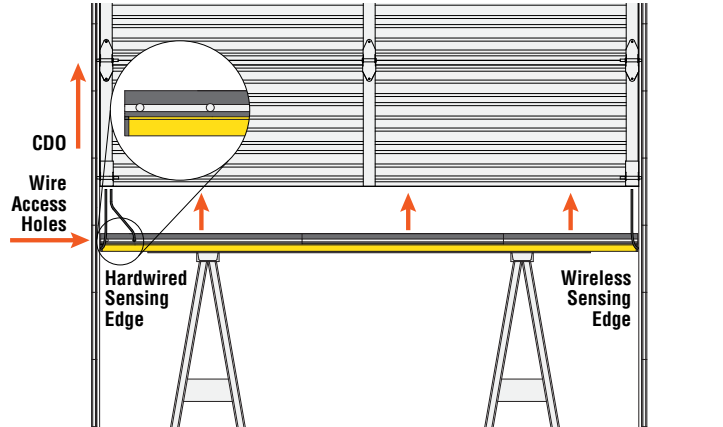

**IMAGE 2: A work surface for channel assembly and installation**

### 2. Cut mounting channel:

- a. Set aside the mounting channel with wire access holes.
- b. Measure the total width of the door section.
- c. Trim one mounting channel section without wire access holes so the total assembled channel length matches the door width and sensing edge or loop seal.
  - **Tip:** Perform a dry fit before final assembly to confirm width and alignment.



**IMAGE 3: Cut and arrange the mounting channel sections**

### 3. Assemble Mounting Channel to Sensing Edge or Weather Seal:

- a. Determine wire outlet orientation: **IMAGE 2**
  - **Hardwired sensing edge:** The wire or air-tube outlet will be positioned **below** the CDO.
  - **Wireless sensing edge:** The wire or air-tube outlet will be positioned on the **opposite side** of the door from the CDO.
- b. Arrange the mounting channel sections on the work surface end-to-end with the sensing edge or loop seal T-slots facing upward. **IMAGE 3, IMAGE 4-1**
- c. On the CDO side of the door, slide the mounting channel **with wire-access holes** onto the sensing edge or loop seal. **IMAGE 2, IMAGE 4-2**
- d. Then slide the remaining mounting channel sections onto the opposite end—eliminating all gaps.

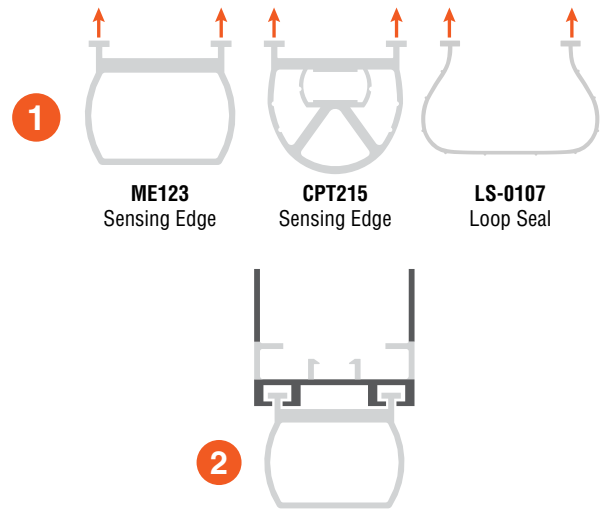

**IMAGE 4: Preparing Aries for mounting—sensing edge and weather seal not provided**

### 4. Install LED Strip into Mounting Channel:

- a. Lay the LED strip onto the mounting channel with the lead wire on the CDO side of the door. **IMAGE 5-1**
- b. Confirm the LED emitters are facing upward toward the door panel.
- c. Position the LED strip so it's centered below the door to ensure proper alignment when installed on the door. **IMAGE 6**
- d. Starting at the non-wired end, press the LED strip into the center LED retainer until fully seated. **IMAGE 5-2**
  - o **Important:** The LED strip should lay flat within the center LED retainer. Do not pinch or twist the LED strip or cable during installation.
- e. Route the LED wire through the nearest wire access hole to the interior of the door. **IMAGE 7, IMAGE 8**



**IMAGE 5:** Installing the LED strip and the Aries mounting channel onto a bottom door section

### 5. Install Mounting Channel Assembly to Door (two installers recommended):

- a. Lift the assembled channel into position along the bottom of the door. **IMAGE 9**
- b. Secure the channel using self-tapping screws (not provided) at both ends of each channel section: **IMAGE 5-3**
  - o **Insulated doors:** Fasten through both inside and outside channel faces.
  - o **Uninsulated doors:** If there is no available mounting surface, fasten through the outside channel face only.

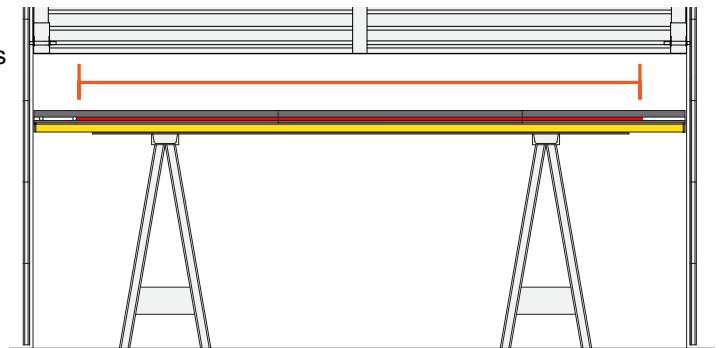

**IMAGE 6:** LED strip centered on door

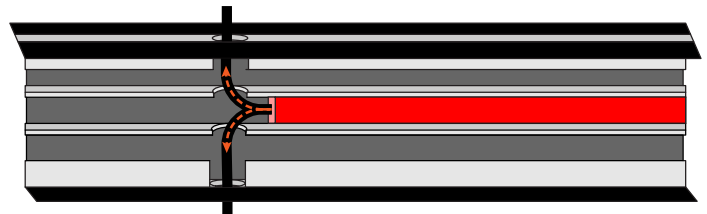

**IMAGE 7:** Directional LED wire routing options

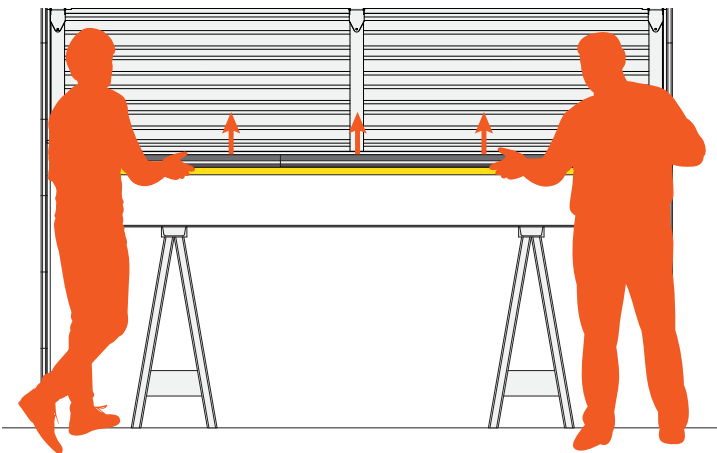

**IMAGE 9:** Installing the mounting channel assembly to the door (two installers recommended)

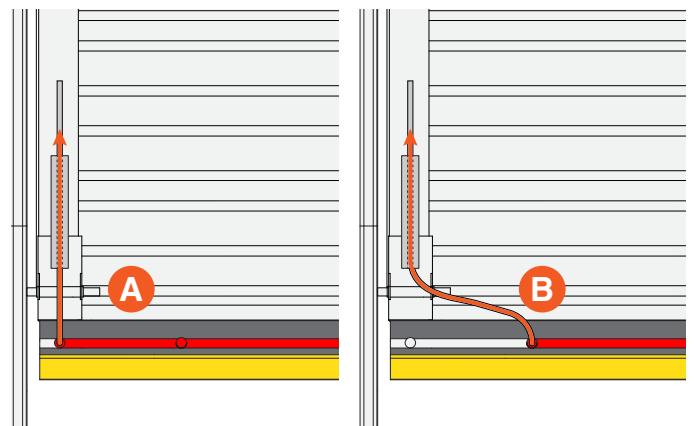

**IMAGE 8:** Routing the LED cable through the appropriate mounting channel wire access hole and the optional cable raceway

## II. Junction Box Installation & Door-Mounted Wiring

### 1. Setup:

- Identify these parts:
  - (1) Cable raceway
  - (1) Coil cord
  - (1) Junction box
  - (1) 90° cord grip
  - (1) Straight cord grip
  - (4) Wire nuts

### 2. Install Junction Box

- a. Remove junction box cover. **IMAGE 10-1**
- b. Remove appropriate knockouts per local electrical code.
- c. Install:
  - Top: **90° cord grip** for coil cord
  - Bottom: **Straight cord grip** for LED strip wiring
- d. Mount the junction box with the appropriate fasteners (not provided) on the end stile, 3-6 in. above the mounting channel.

### 3. Connect the LED Strip & Coil Cord

- a. Connect the LED strip to the LED strip extension cable at the threaded connector. **IMAGE 10-2**
  - **Tip:** The 4-ft. LED strip extension cable may be used as supplied, shortened, or omitted entirely. If omitted, the threaded connector can be cut—strip the cables and connect the LED strip directly to the coil cord within the junction box.
- b. Feed the LED strip cable and the coil cord through the cord grips and tighten securely.
- c. Take up all excess LED cable to maintain a clean, secure installation along the door. Cut off any excess LED strip cable.
- d. Strip both ends of the coil cord:
  - Cable jacket: **0.75 in.**
  - Each wire: **0.25 in.**
- e. Using wire nuts, connect the LED strip wires to the coil cord wires within the junction box according to **Table 1**.
- f. Reinstall the junction box cover.

### 6. Sensing Edge Connection

(proceed to next step if using LS-0107 loop seal)

- **Hardwired systems: IMAGE 11-A**  
Wire the sensing edge and Aries using the same coil cord per **Table 1** and following the CDO and sensing edge installation instructions.
- **Wireless systems: IMAGE 11-B**  
Align the outlet location opposite of the CDO and complete installation per wireless system instructions.

### 4. Install Optional Cable Raceway

If needed for cable management, mount the cable raceway onto the door positioned in the gap between the wire outlet and the side of the door: **IMAGE 10-3**

- a. Cut the raceway to the required length.
- b. Clean the door mounting surface.
- c. Remove VHB tape backing and mount the raceway to the door.
- d. Route the cable into the raceway and reinstall lid.
  - **Tip:** The cable raceway can be mounted vertically or horizontally to best manage cables.

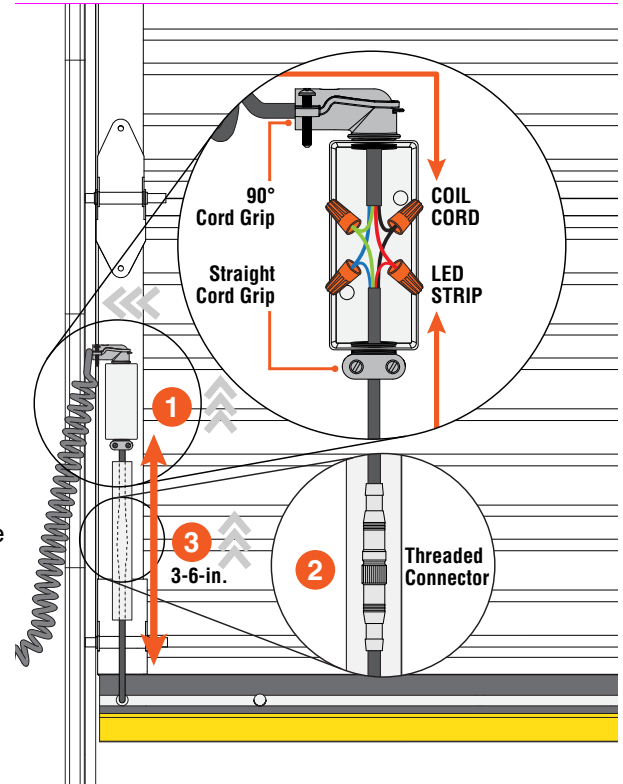

**IMAGE 10: Junction box & optional raceway placement & wiring**

**TABLE 1: Coil Cord Wiring**

Coil Cord	LED Strip	Sensing Edge
● Blue	→← ● Blue	-
● Green	→← ● Green	-
● Red	→← ● Red	-
● Black	→← ● Black	-
● Black/White Stripe	→← -	● Black
● White	→← -	● White

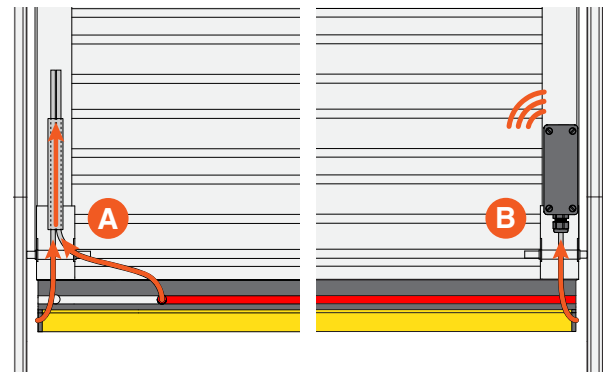

**IMAGE 11: Sensing edge connection options shown with a universal outlet location**

### III. Controller Box Installation & Wiring

1. **Setup:**
  - a. Identify these parts:
    - Controller Box (includes Power Supply & Door LED Controller—assembled)
    - Coil Cord
    - CDO Signal Wire
2. **Mount the Controller Box**
  - a. Mount on the same side as the CDO, approximately mid-door height. **IMAGE 12**
  - b. Rotate the enclosure so cord grips face the door.
  - c. Secure to wall using mounting tabs and the appropriate fasteners (not provided). **IMAGE 13**
3. **Connect the Coil Cord to the Door LED Controller:**
  - a. Open the lid of the controller box. **IMAGE 13**
  - b. Route the coil cord end—clear of moving components and into the controller box—through center cord grip.
  - c. Remove the right terminal block labeled *Main LED Strip*.
  - d. Connect each wire to the terminals according to **Table 2** using the provided 3 mm Phillips/flathead screwdriver.
  - e. Tighten terminal screws and reinstall the terminal block.
4. **Connect the CDO Signal Wire to the Door LED Controller**
  - a. Strip both ends of the CDO signal wire: **IMAGE 13**
    - Cable jacket: **0.75-in.**
    - Each wire: **0.25-in.**
  - b. Remove the left terminal block labeled *Door Operator*.
  - c. Connect each wire to the terminals according to **Table 3** using the provided 3 mm Phillips/Flathead Screwdriver.
  - d. Tighten terminal screws and reinstall the terminal block.
  - e. Tighten all cord grips and close the controller box lid.

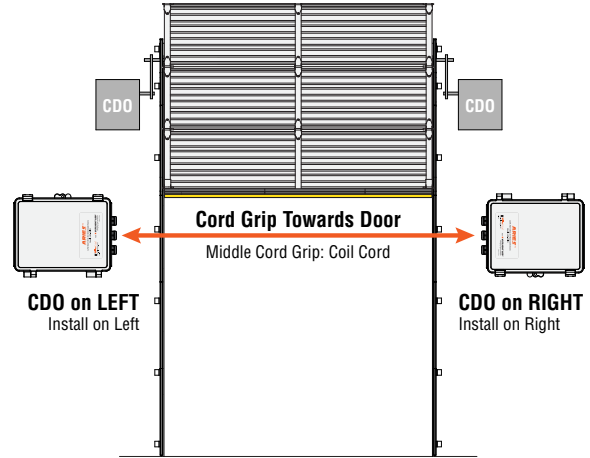

**IMAGE 12: Controller Box Orientation & Cord Grip Assignment (not to scale)**

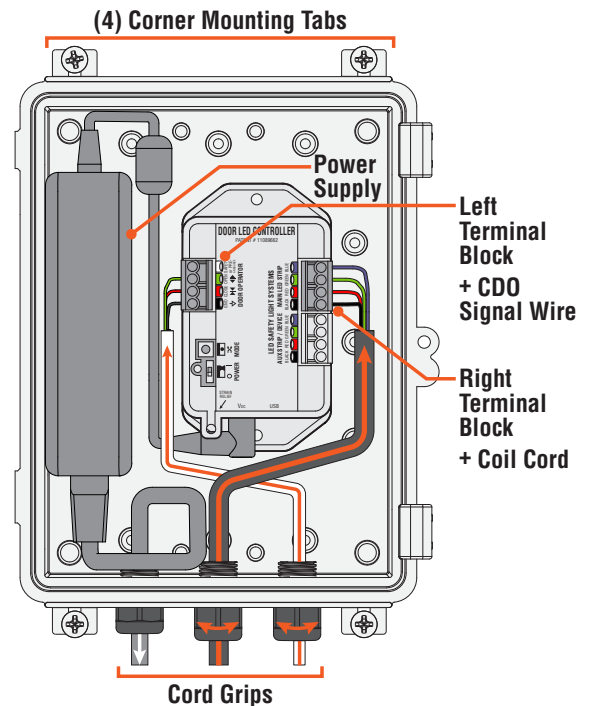

**IMAGE 13: Controller Box Wiring**

**TABLE 2: Coil Cord to LED Controller Wiring**  
Terminal Location: Top-Right "Main LED Strip"

Coil Cord	Terminal Position
● Blue	→ ● BLUE
● Green	→ ● GREEN
● Red	→ ● RED
● Black	→ ● BLACK

**TABLE 3: Signal Wire to LED Controller Wiring**  
Terminal Location: Left "Door Operator"

Signal Wire	Terminal Position
● Green	→ OPEN
● Red	→ CLOSE
● Black	→ GND
● White (not used)	× -
● Yellow (not used)	× -
● Blue (not used)	× -

### IV. Power Source Connection

1. Route the CDO signal and power supply wires along a fixed surface and secure it to prevent interference with moving door components. **IMAGE 14**
2. Verify controller power switch is **OFF**.
3. Connect the power supply to a 115–230 VAC source.
  - **Note:** The included power supply cable has a grounded 3-prong plug for standard 115 VAC wall outlet connection. If wiring directly to a power source, the plug may be removed.
  - **Important:** All direct wiring must be performed by a qualified electrician and comply with national and local electrical codes.

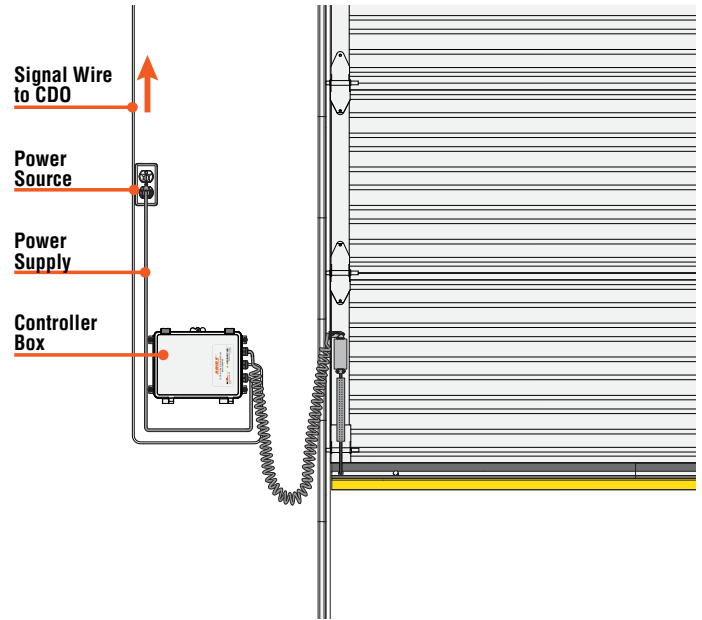

**IMAGE 14: Controller Box Wiring**

### V. Connect the Door LED Controller to the CDO

1. Connect the CDO Signal Wire to the operator input according to the following brand-specific wiring diagrams:

#### Manaras Opera CDO Wiring Schematic

With both the CDO and the Door LED Controller powered **OFF**, connect the Signal Wire to the CDO as shown in the diagram.

SIGNAL WIRE	LED CONTROLLER	CDO
● Green	OPEN	↔ OPEN L/S (NO)
● Red	CLOSE	↔ CLOSE L/S (NO)
● Black	GND	↔ 3: COM
● White	(not used)	✗ -
● Yellow	(not used)	✗ -
● Blue	(not used)	✗ -

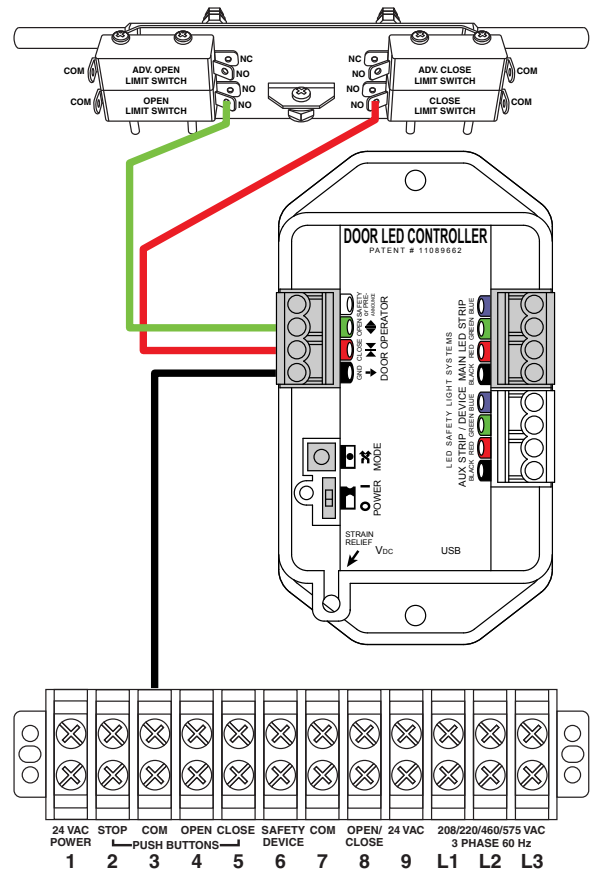

## Overhead Door RSX CDO Wiring Schematic

**Note:** This Overhead Door model CDO requires use of the OHD-brand Auxiliary Output Module (AOM).

With both the CDO and the Door LED Controller powered **OFF**, connect the Signal Wire to the CDO as shown in the diagram.

SIGNAL WIRE	LED CONTROLLER	CDO	AOM
● Green	OPEN	↔	N.O. UP2
● Red	CLOSE	↔	N.O. DN2
● Black	GND	↔	GND UP2 + DN2
● White	(not used)	✘	-
● Yellow	(not used)	✘	-
● Blue	(not used)	✘	-

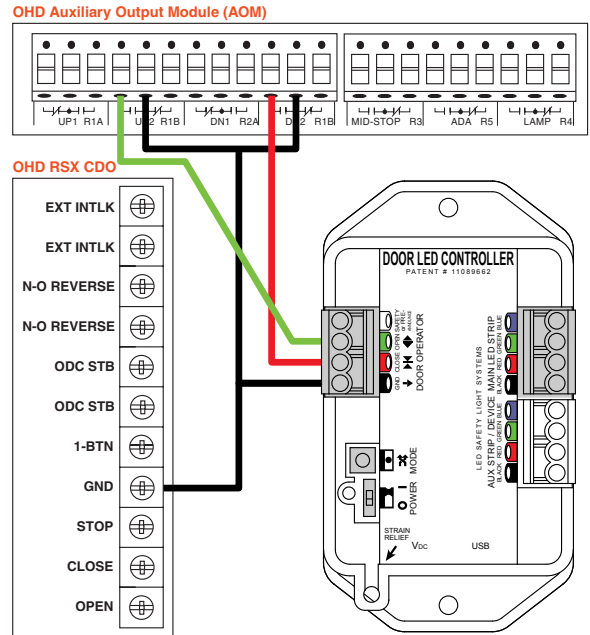

## LiftMaster Logic 4/5 CDO Wiring Schematic

With both the CDO and the Door LED Controller powered **OFF**, connect the Signal Wire to the CDO as shown in the diagram.

SIGNAL WIRE	LED CONTROLLER	CDO
● Green	OPEN	↔ OPEN L/S (NO)
● Red	CLOSE	↔ CLOSE L/S (NO)
● Black	GND	↔ 11: COMMON
● White	(not used)	✘ -
● Yellow	(not used)	✘ -
● Blue	(not used)	✘ -

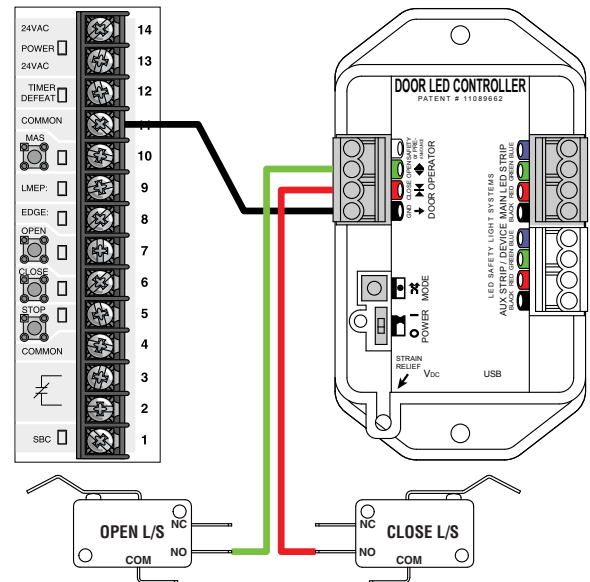

More brand-specific CDO wiring diagrams:



<https://www.brinkalert.com/door-schematics>

If the CDO is not listed, follow the QR Code for more brand/model wiring diagrams.

**Note:** Refer to the CDO manufacturer's manual for operator-specific input requirements.

## VI. System Activation & Testing

1. Dress all visible wiring.
2. **Restore power** to the CDO.
3. Switch the LED controller to **ON**.
4. Cycle the door fully open and closed.
5. Confirm normal function of the LED Controller (**Table 4**) and LED strip (**Table 5**).
6. When normal function is confirmed, the Aries system is operational.

**TABLE 4: Normal Function of the LED Controller Indicators**

LED Indicator	Door Action	Pattern
● Red	Closed	On, steady
● White	In-motion	On, steady
● Green	Open	On, steady

**TABLE 5: Normal Function of the LED Strip**

LED Strip Color	Door Action	Pattern
● Green	Opened	On, steady
● Red	In-motion	On, flashing
● Red	Closed	On, steady

## VII. Troubleshooting

1. **Issue:** LED strip does not turn on  
**Diagnosis:** Power supply issue(s)  
**Possible Solutions:**
  - Confirm normal function of the LED controller indicators per **Table 4**
  - Inspect LED controller terminal blocks: **Section III**
    - Ensure wires are fully seated and secured and terminal blocks are fully reinstalled.
    - Confirm the wire colors and labels on the LED Controller are matched with the CDO signal and coil cord wires per **Table 2** and **Table 3**.
  - Trace the CDO signal and coil cord wiring from the LED Controller to confirm connection and power.
  - Confirm the threaded connector for the LED Strip cable and LED strip extension cable is mated—inspect pins inside the connector for proper alignment.
2. **Issue:** LED strip does not change color or keeps flashing red  
**Diagnosis:** Signal wire issue(s)  
**Possible Solutions:**
  - Trace the CDO signal wire from the LED Controller to CDO to confirm connection.
  - Refer to the operator-specific wiring schematics to confirm the connections are correct. **Section V**
  - Ensure the LED Controller is properly grounded—GND on the LED Controller → Common/Ground on the CDO.
  - If after checking the above, the LED strip does not display normal function per **Table 5**, contact Tech Support.

## VIII. Tech Support

**LED LIGHT STRIP**

**Mounting & Wiring**

Contact Miller Edge  
800-220-3343, dial option 3

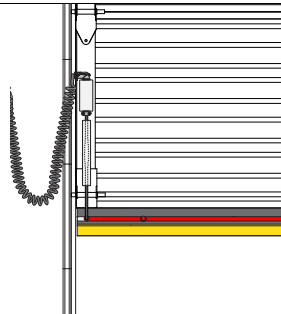

**LED CONTROLLER**

**Wiring & Programming**

Contact Brink Alert  
786-339-9840



## IX. General Specifications

### LED STRIP

LEDs	18 bi-color LED lights per foot	
Brightness	Red: 532 lm/m	Green: 2,392 lm/m
Signaling	Door Open: Green	Door Closed: Red
	Door Opening: Red, flashing	Door Closing: Red, flashing
Lifespan	44,000 hours	

### PERFORMANCE

Illumination Mode	Continuous (always on)	
Activation	Commercial door operator-signal activated	
Operating Temperature	-30° to +140°F (-34° to 60°C)	

### ELECTRICAL

Power Source	115-230V power supply, 24V LED via wall outlet	
--------------	--	--

### PHYSICAL

Mounting/Visibility	Interior mounting; visible from both interior and exterior	
Dimensions	Controller box: 7 W x 9.5 H x 4 D-in. (178 x 241 x 102 mm)	LED strip length by model: - LED-ARIES-ME123C-K8: 7-ft. 6-in. (2.3 m) - LED-ARIES-ME123C-K10: 10-ft. 2-in. (3.1 m) - LED-ARIES-ME123C-K12: 11-ft. 9-in. (3.6 m) - LED-ARIES-ME123C-K14: 14-ft. 1-in. (4.3 m)
Cable Lengths	LED strip cable: 1-ft. (0.3 m) LED strip extension cable: 4-ft. (2.4 m)	CDO signal cable: 20-ft. (6.1 m) Power supply cable: 3-ft. (0.9 m)
Weight (door mounted components)	Mounting channel: 4.4 oz./ft. LED strip: 0.9 oz./ft.	Raceway: 1.9 oz. Junction box and components: 7.3 oz. Coil cord: 15.25 oz.
Material	LED Strip: UV protected silicone sheath	Mounting Channel: High density rigid PVC
LED Indicators (LED Controller)	Green: Door is open Red: Door is closed	White (pulsing): Door is in motion
Mounting	Mounted to the leading edge of a 1.75-in. to 2-in. sectional door with the appropriate fasteners	
Degree of Protection	LED strip component: IP68	LED Controller enclosure: NEMA 4

## X. Maintenance

It is strongly recommended that users check their **Aries (LED-ARIES)** at least once per month for proper function of the LED Strip and damage to housings and mountings. Also check for signs of damage to cables or connection points. Refer to the commercial door operator manual for detailed instructions about motor connections.

## XI. Warranty

**Aries (LED-ARIES)** carries a **2-year warranty** from date of shipment from Miller Edge for credit or replacement. This warranty applies to normal use, which is found to have defective materials or workmanship, as determined solely by an authorized factory representative. This warranty is void where evidence of misuse or abuse is present. This warranty covers repair or replacement of the purchased product only; product installation/labor charges are not covered. Miller Edge manufactures its products to meet stringent specifications and cannot assume responsibility for those consequences arising from improper installation or misuse. Installation instructions and testing procedures provided by Miller Edge must be followed for proper operation and maintenance.

## XII. Accessories

Contact your Miller Edge sales representative for accessories:

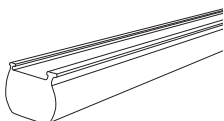

Sensing Edges

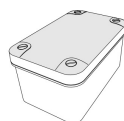

Junction Boxes

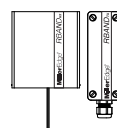

Wireless Systems

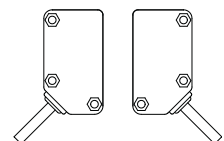

Photo Optics